

BEELED

СВЕТОДИОДЫ BEELED – ТЕХНИЧЕСКОЕ ОПИСАНИЕ

MODEL: 8034W2C-CSD-B

Features

- High efficiency
- Low Power consumption
- General purpose leads
- Selected minimum intensities
- Available on tape and reel
- Pb free

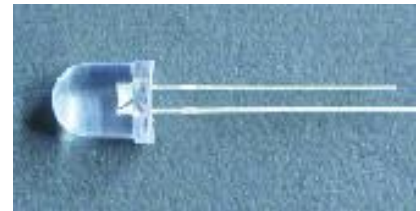

Descriptions

- The series is specially designed for applications requiring higher brightness
- The LED lamps are available with different colors, intensities, epoxy colors, etc
- Superior performance in outdoor environment



Usage Notes:

- The ultra bright LED is an electrostatic insensitive device, so static electricity and surge will damage the LED. It is required to wear a wrist-band when handling the LED. All device, equipment, machinery, desk and ground must be properly grounded
- When using LED, it must use a protective resistor in series with DC current about 20mA

Applications

- Status indicators
- Commercial use
- Advertising Signs
- Back lighting

Device Selection Guide

BEELED

СВЕТОДИОДЫ BEELED – ТЕХНИЧЕСКОЕ ОПИСАНИЕ

MODEL: **8034W2C-CSD-B**

LED Part No.	Chip		Lens Color
	Material	Emitted Color	
8034W2C-CSD-B	InGaN	White	Water clear

Package Dimensions

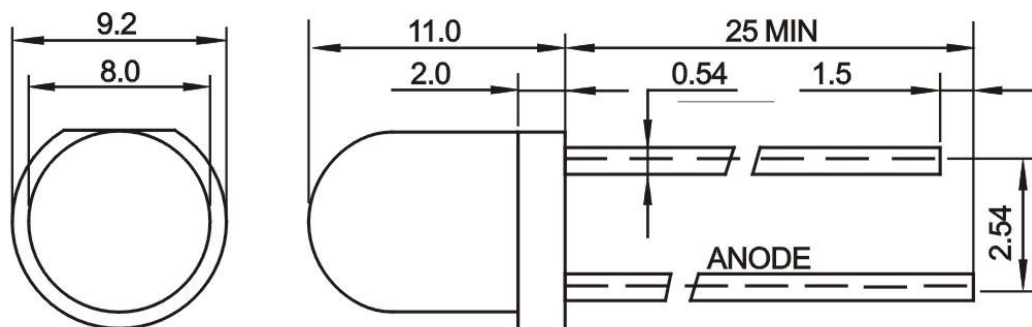

UNIT:mm

Notes:

- Other dimensions are in millimeters, tolerance is 0.25mm except being specified.
- Protruded resin under flange is 1.5mm Max LED.
- Bare copper alloy is exposed at tie-bar portion after cutting.

Absolute Maximum Rating ($T_a=25^{\circ}\text{C}$)

Parameter	Symbol	Absolute Maximum Rating	Unit
Forward Pulse Current	I_{FPM}	70	mA



СВЕТОДИОДЫ BEELED – ТЕХНИЧЕСКОЕ ОПИСАНИЕ

MODEL: 8034W2C-CSD-B

Forward Current	I_{FM}	30	mA
Reverse Voltage	V_R	5	V
Power Dissipation	P_D	140	mW
Operating Temperature	T_{opr}	-40~+80	°C
Storage Temperature	T_{stg}	-40~+100	°C
Soldering Heat (5s)	T_{sol}	260	°C

Electro-Optical Characteristics ($T_a=25^{\circ}C$)

Parameter	Symbol	Min.	Typ.	Max.	Unit	Test Condition
Luminous Intensity	I_V	6000	6800	---	mcd	IF=20mA(Note 1)
Viewing Angle	$2\theta_{1/2}$	20	25	30	Deg	(Note 2)
Peak Emission Wavelength	λ_p	---	---	---	nm	IF=20mA
Spectral Line Half-Width	$\Delta\lambda$	25	30	35	nm	IF=20mA
Forward Voltage	V_F	2.9	---	3.5	V	IF=20mA
Reverse Current	I_R	---	---	10	μA	VR=5V

Note:

1. Luminous intensity is measured with a light sensor and filter combination that approximates the CIE eye-response curve.
2. $\theta_{1/2}$ is the off-axis angle at which the luminous intensity is half the axial luminous intensity.



СВЕТОДИОДЫ BEELED – ТЕХНИЧЕСКОЕ ОПИСАНИЕ

MODEL: 8034W2C-CSD-B

Typical Electro-Optical Characteristics Curves

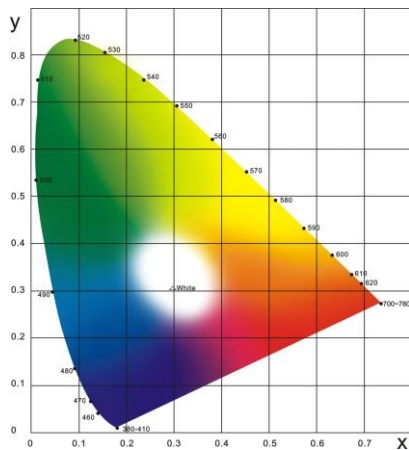

Relative Intensity VS. Ambient Temp

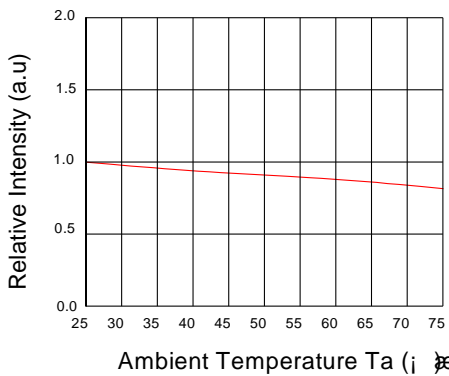

Forward Current VS.Ambient Temp.

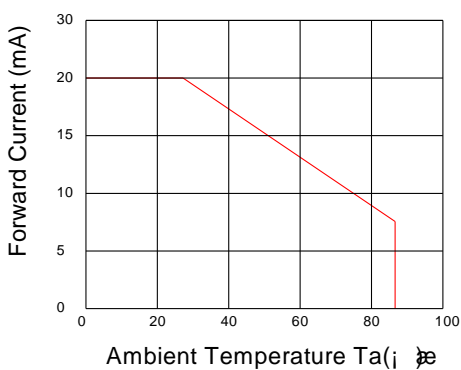

Forward Current VS.Forward Voltage

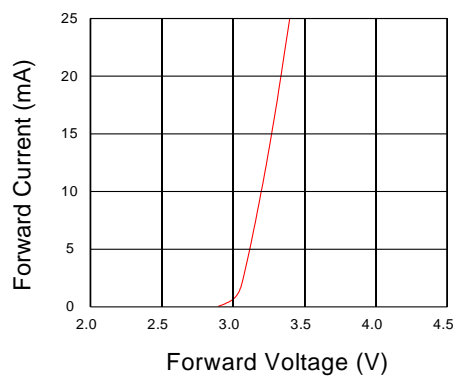

Forward Current VS.Relative Intensity

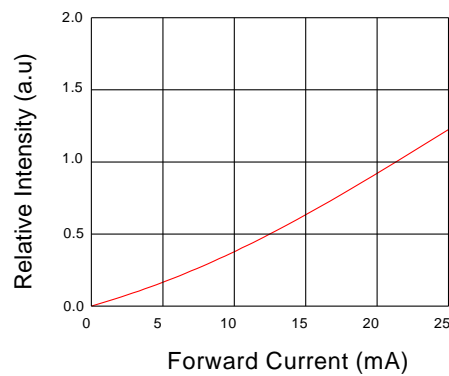

Radiation Characteristics

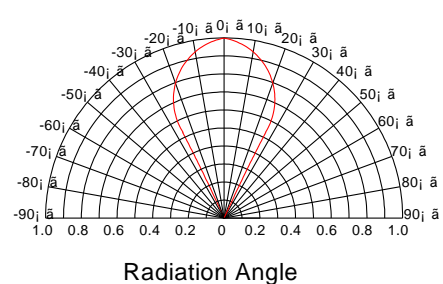



СВЕТОДИОДЫ BEELED – ТЕХНИЧЕСКОЕ ОПИСАНИЕ

MODEL: 8034W2C-CSD-B

Notes

1. Above specification may be changed without notice. BEELED will reserve authority on material change for above specification.
2. When using this product, please observe the absolute maximum ratings and the instructions for using outlined in these specification sheets. BEELED assumes no responsibility for any damage resulting from use of the product which does not comply with the absolute maximum ratings and the instructions included in these specification sheets.
3. These specification sheets include materials protected under copyright of BEELED corporation. Please don't reproduce or cause anyone to reproduce them without BEELED's consent.